

Bioengineering 280A
Principles of Biomedical Imaging

Fall Quarter 2007
Ultrasound Lecture 2

TT Liu, BE280A, UCSD, Fall 2007

Single-slit Diffraction

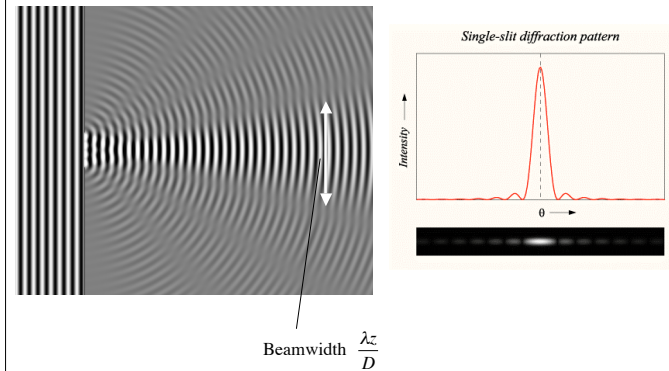

TT Liu, BE280A, UCSD, Fall 2007

Source:wikipedia

Plane Wave Approximation

In general

$$U(x_0, y_0) = \frac{1}{z} \exp\left(j \frac{2\pi z}{\lambda}\right) F\left[s(x, y)\right]_{k_x = \frac{x_0}{\lambda z}, k_y = \frac{y_0}{\lambda z}}$$

Example

$$s(x, y) = \text{rect}(x/D) \text{rect}(y/D)$$

$$U(x_0, y_0) = \frac{1}{z} \exp(jkz) D^2 \text{sinc}(Dk_x) \text{sinc}(Dk_y)$$

$$= \frac{1}{z} \exp(jkz) D^2 \text{sinc}\left(D \frac{x_0}{\lambda z}\right) \text{sinc}\left(Dk_y \frac{y_0}{\lambda z}\right)$$

Zeros occur at $x_0 = \frac{n\lambda z}{D}$ and $y_0 = \frac{n\lambda z}{D}$

Beamwidth of the sinc function is $\frac{\lambda z}{D}$

TT Liu, BE280A, UCSD, Fall 2007

Huygen's Principle

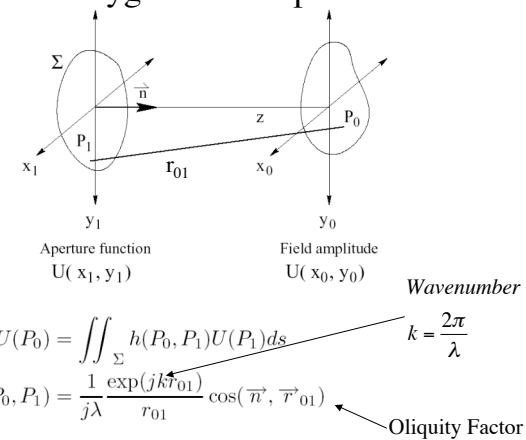

TT Liu, BE280A, UCSD, Fall 2007

Anderson and Trahey 2000

Small-Angle (paraxial) Approximation

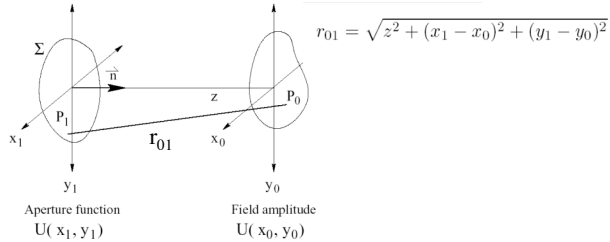

$$\begin{aligned} \cos(\vec{n}, \vec{r}_{01}) &\approx 1 \\ r_{01} &\approx z \\ h(x_0, y_0; x_1, y_1) &\approx \frac{1}{j\lambda z} \exp(jkr_{01}) \end{aligned}$$

TT Liu, BE280A, UCSD, Fall 2007

Anderson and Trahey 2000

Fresnel Approximation

$$\begin{aligned} r_{01} &= \sqrt{z^2 + (x_1 - x_0)^2 + (y_1 - y_0)^2} \\ &= z \sqrt{1 + \left(\frac{x_1 - x_0}{z}\right)^2 + \left(\frac{y_1 - y_0}{z}\right)^2} \\ &\approx z \left[1 + \frac{1}{2} \left(\frac{x_1 - x_0}{z}\right)^2 + \frac{1}{2} \left(\frac{y_1 - y_0}{z}\right)^2 \right] \end{aligned}$$

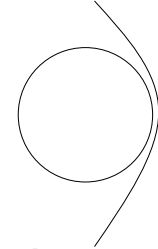

Approximates spherical wavefront with a parabolic phase profile

$$h(x_0, y_0; x_1, y_1) \approx \frac{\exp(jkz)}{j\lambda z} \exp\left[\frac{jk}{2z} \left[(x_1 - x_0)^2 + (y_1 - y_0)^2 \right]\right]$$

TT Liu, BE280A, UCSD, Fall 2007

Anderson and Trahey 2000

Fresnel Approximation

$$\begin{aligned} U(x_0, y_0) &= \iint \frac{1}{j\lambda r_{01}} \exp(jkr_{01}) s(x_1, y_1) dx_1 dy_1 \\ &\approx \iint \frac{1}{j\lambda z} \exp\left(jk\left(z^2 + (x_1 - x_0)^2 + (y_1 - y_0)^2\right)\right) s(x_1, y_1) dx_1 dy_1 \\ &\approx \iint \frac{\exp(jkz)}{j\lambda z} \exp\left(\frac{jk}{2z} \left((x_1 - x_0)^2 + (y_1 - y_0)^2\right)\right) s(x_1, y_1) dx_1 dy_1 \\ &= \frac{\exp(jkz)}{j\lambda z} \left(s(x_0, y_0) ** \exp\left(\frac{jk}{2z} (x_0^2 + y_0^2)\right) \right) \end{aligned}$$

TT Liu, BE280A, UCSD, Fall 2007

Fresnel Zone

$$\begin{aligned} U(x_0, y_0) &\approx \iint \frac{\exp(jkz)}{j\lambda z} \exp\left(\frac{jk}{2z} \left((x_1 - x_0)^2 + (y_1 - y_0)^2\right)\right) s(x_1, y_1) dx_1 dy_1 \\ &= \iint \frac{\exp(jkz)}{j\lambda z} \exp\left(\frac{jk}{2z} \left((x_1^2 + y_1^2) + (x_0^2 + y_0^2) - 2(x_1 x_0 + y_1 y_0)\right)\right) s(x_1, y_1) dx_1 dy_1 \\ &= \frac{\exp(jkz)}{j\lambda z} \exp\left(\frac{jk}{2z} (x_0^2 + y_0^2)\right) \times \\ &\quad \iint \frac{\exp(jkz)}{j\lambda z} \exp\left(\frac{jk}{2z} (x_1^2 + y_1^2)\right) s(x_1, y_1) \exp\left(-\frac{jk}{z} (x_1 x_0 + y_1 y_0)\right) dx_1 dy_1 \\ &= \frac{\exp(jkz)}{j\lambda z} \exp\left(\frac{jk}{2z} (x_0^2 + y_0^2)\right) F \left[\exp\left(\frac{jk}{2z} (x_1^2 + y_1^2)\right) s(x_1, y_1) \right] \end{aligned}$$

Phase across transducer face

TT Liu, BE280A, UCSD, Fall 2007

Fraunhofer Condition

Phase term due to position on transducer is $\frac{k}{2z}(x_1^2 + y_1^2)$

Far-field condition is

$$\frac{k}{2z}(x_1^2 + y_1^2) \ll 1$$

$$z \gg \frac{k}{2}(x_1^2 + y_1^2) = \frac{\pi}{\lambda}(x_1^2 + y_1^2)$$

For a square $D \times D$ transducer, $x_1^2 + y_1^2 = D^2/2$

$$z \gg \frac{\pi D^2}{2\lambda} \approx \frac{D^2}{\lambda}$$

TT Liu, BE280A, UCSD, Fall 2007

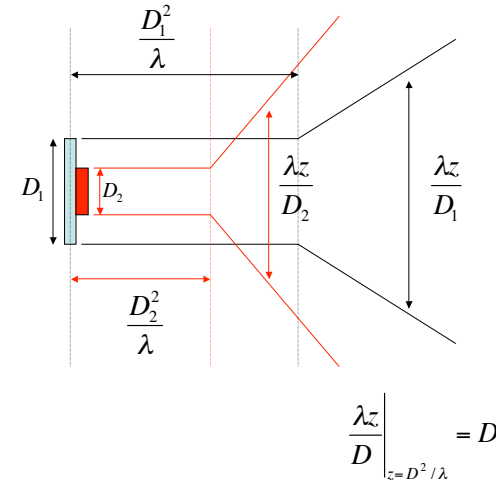

TT Liu, BE280A, UCSD, Fall 2007

Fresnel Zone

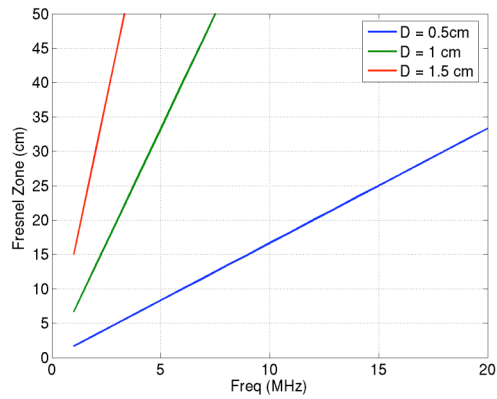

TT Liu, BE280A, UCSD, Fall 2007

Anderson and Trahey 2000

Focusing in Fresnel Zone

$$U(x_0, y_0) = \frac{\exp(jkz)}{j\lambda z} \exp\left(\frac{jk}{2z}(x_0^2 + y_0^2)\right) F\left[\exp\left(\frac{jk}{2z}(x_1^2 + y_1^2)\right) s(x_1, y_1)\right]$$

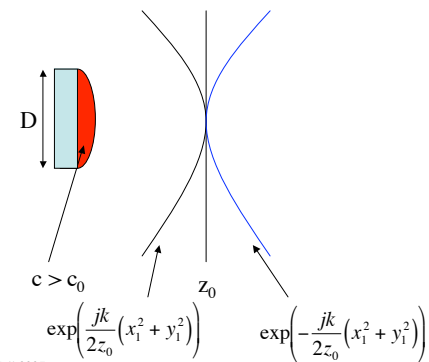

TT Liu, BE280A, UCSD, Fall 2007

Focusing in Fresnel Zone

$$U(x_0, y_0) = \frac{\exp(jkz)}{j\lambda z} \exp\left(\frac{jk}{2z}(x_0^2 + y_0^2)\right) F\left[\exp\left(\frac{jk}{2z}(x_1^2 + y_1^2)\right) s(x_1, y_1)\right]$$

Make

At the focal depth $z = z_0$

$$U(x_0, y_0) = \frac{\exp(jkz_0)}{j\lambda z_0} \exp\left(\frac{jk}{2z_0}(x_0^2 + y_0^2)\right) F[s(x_1, y_1)]$$

Beamwidth at the focal depth is: $\frac{\lambda z_0}{D}$

$$s(x_1, y_1) = s_0(x_1, y_1) \exp\left(-\frac{jk}{2z_0}(x_1^2 + y_1^2)\right)$$

TT Liu, BE280A, UCSD, Fall 2007

Acoustic Lens

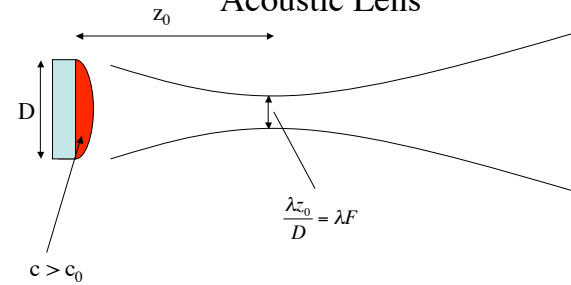

At the focal depth $z = z_0$

$$\begin{aligned} U(x_0, y_0) &= \frac{\exp(jkz_0)}{j\lambda z_0} \exp\left(\frac{jk}{2z_0}(x_0^2 + y_0^2)\right) F\left[\exp\left(\frac{jk}{2z_0}(x_1^2 + y_1^2)\right) \exp\left(-\frac{jk}{2z_0}(x_1^2 + y_1^2)\right) s(x_1, y_1)\right] \\ &= \frac{\exp(jkz_0)}{j\lambda z_0} \exp\left(\frac{jk}{2z_0}(x_0^2 + y_0^2)\right) F[s(x_1, y_1)] \end{aligned}$$

TT Liu, BE280A, UCSD, Fall 2007

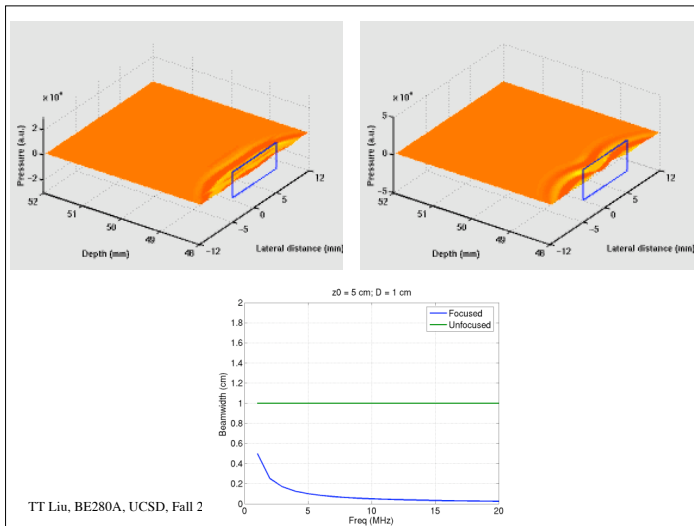

TT Liu, BE280A, UCSD, Fall 2

Depth of Focus

When $z \neq z_0$, the phase term is $\Delta\Phi = \exp\left(-\frac{jk}{2z_0}(x_1^2 + y_1^2)\right) \exp\left(-\frac{jk}{2z}(x_1^2 + y_1^2)\right)$ and the lens is not perfectly focused.

Consider variation in the x -direction.

$$\Delta\Phi = \frac{kx^2}{2} \left(\frac{1}{z} - \frac{1}{z_0}\right)$$

For transducer of size D , $\frac{x^2}{2} = \frac{D^2}{8}$

If we want $|\Delta\Phi| = \left|\frac{\pi D^2}{4\lambda} \left(\frac{1}{z} - \frac{1}{z_0}\right)\right| < 1$ radian then

$$\left|\frac{1}{z} - \frac{1}{z_0}\right| < \frac{4\lambda}{\pi D^2} \approx \frac{\lambda}{D^2} \Rightarrow \frac{\Delta z}{z_0^2} < \frac{\lambda}{D^2}$$

The larger the D , the smaller the depth of focus.

TT Liu, BE280A, UCSD, Fall 2007

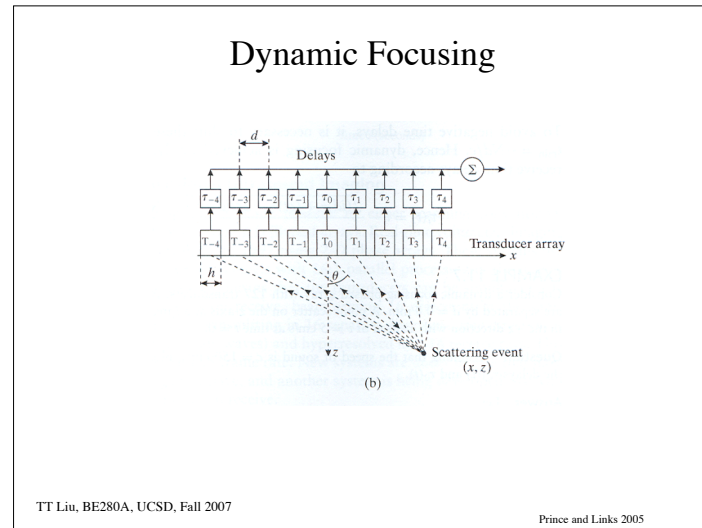
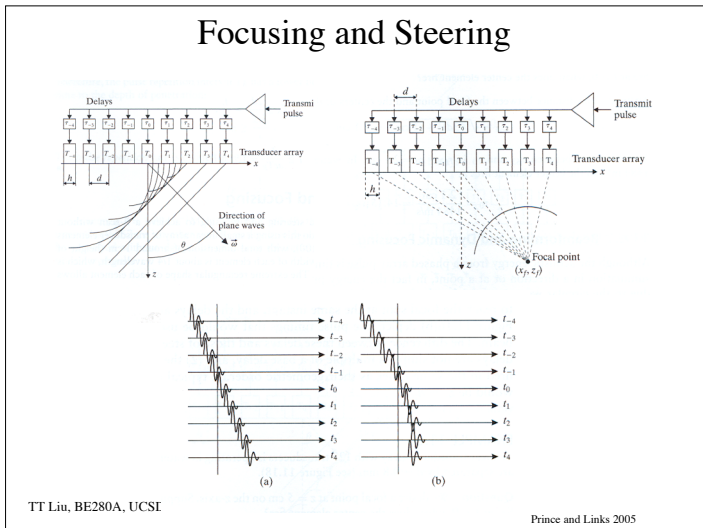
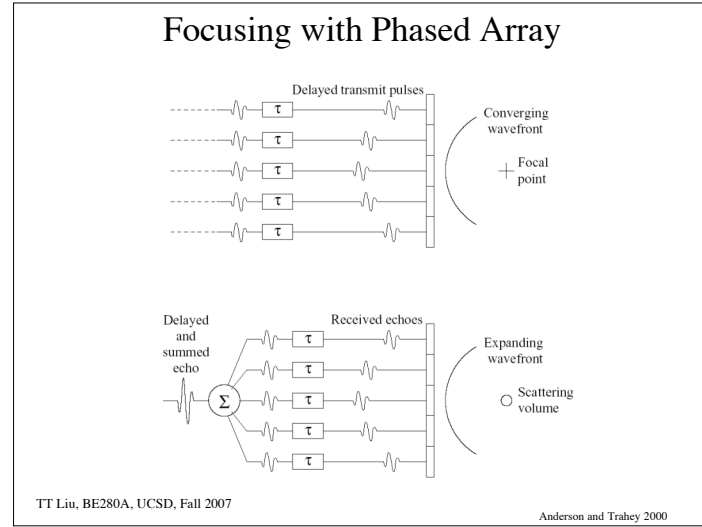
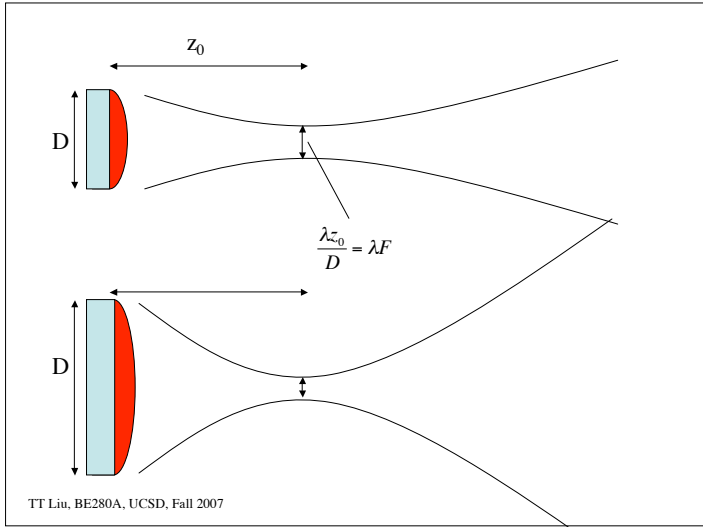

Doppler Effect

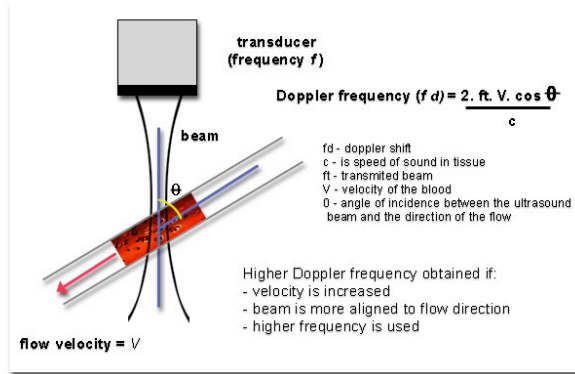

http://www.centrus.com.br/DiplomaFMF/SeriesFMF/doppler/capitulo-htmchapter_01.htm

TT Liu, BE280A, UCSD, Fall 2007

Doppler Effect

$$\Delta f = \frac{2vf_0}{c-v} \approx \frac{2vf_0}{c}$$

Example

$$v = 50 \text{ cm/s}$$

$$c = 1500 \text{ m/s}$$

$$f_0 = 5 \text{ MHz}$$

$$\frac{2vf_0}{c} = 3333 \text{ Hz}$$

TT Liu, BE280A, UCSD, Fall 2007

Doppler

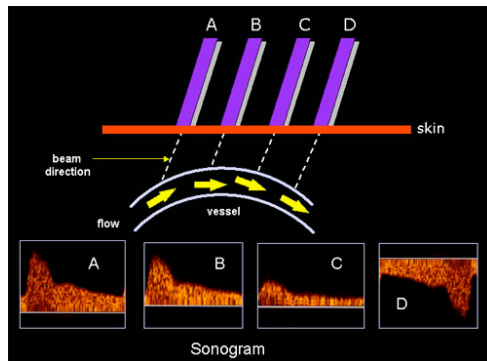

http://www.centrus.com.br/DiplomaFMF/SeriesFMF/doppler/capitulo-htmchapter_01.htm

TT Liu, BE280A, UCSD, Fall 2007

CW Doppler

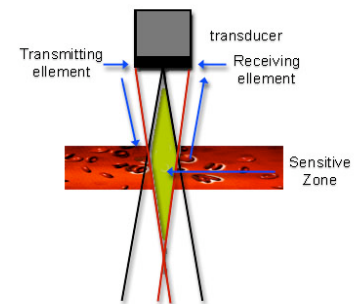

http://www.centrus.com.br/DiplomaFMF/SeriesFMF/doppler/capitulo-htmchapter_01.htm

TT Liu, BE280A, UCSD, Fall 2007

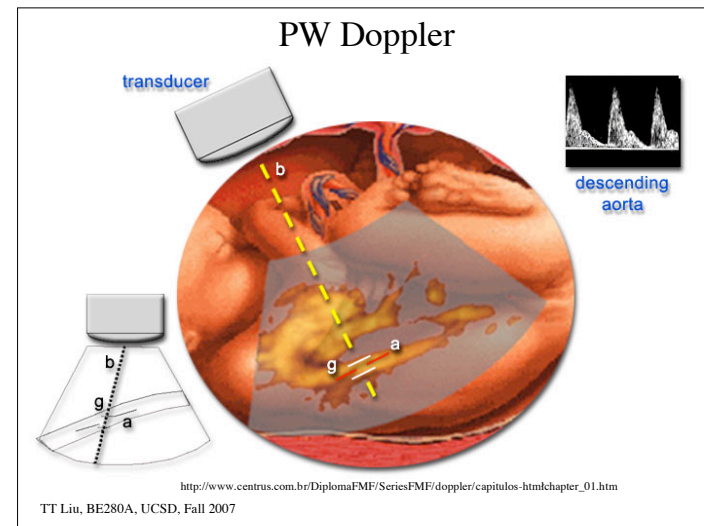
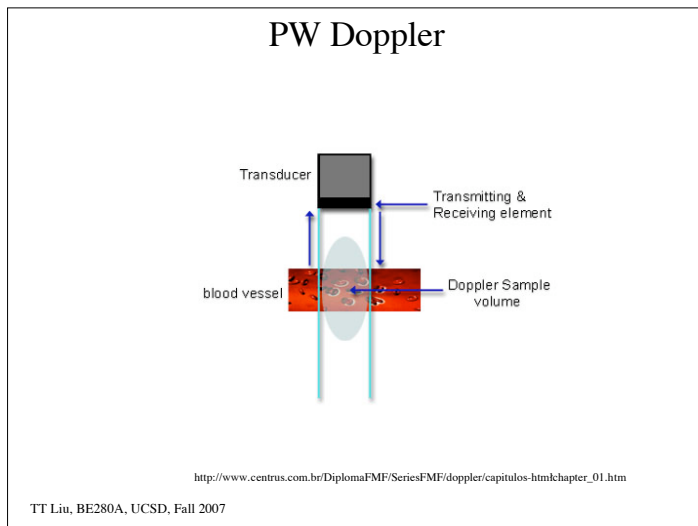
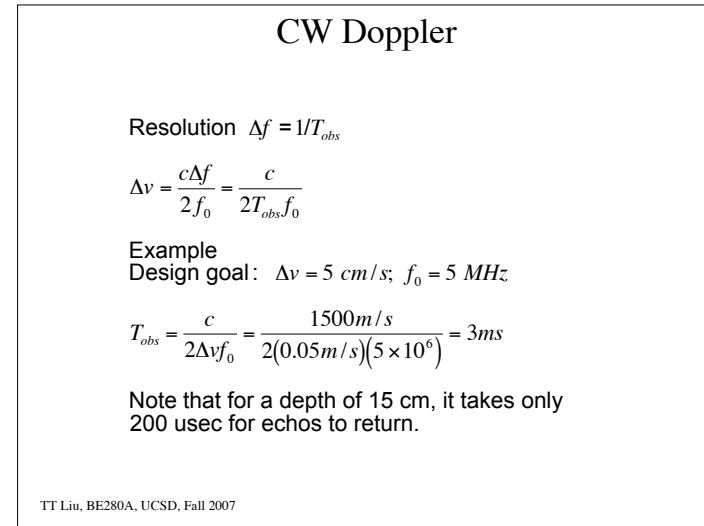
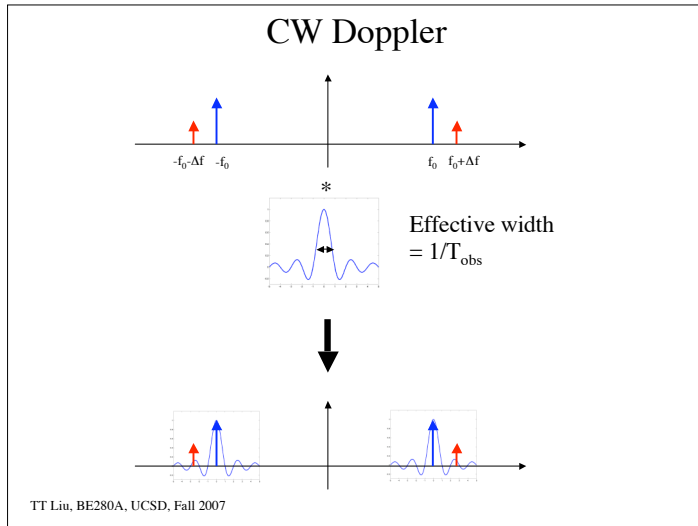

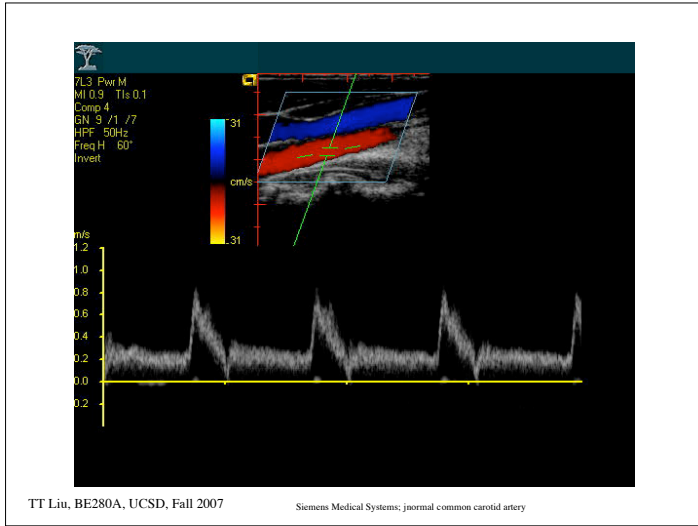

Aliasing

Measure Doppler shifts at a specified range
For unambiguous range, one pulse at a time.

$$T_{PR} = \frac{2r_{max}}{c} \quad (\text{e.g. 200 usec for 15 cm depth})$$

To avoid aliasing require

$$\frac{1}{T_{PR}} > 2\Delta f_{max}$$

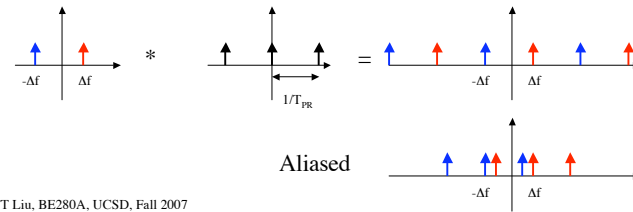

Aliasing

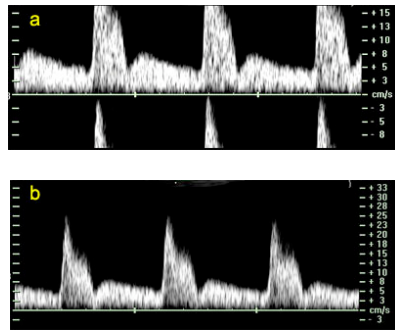

http://www.centrus.com.br/DiplomaFMF/SeriesFMF/doppler/capitulos-htmchapter_01.htm

TT Liu, BE280A, UCSD, Fall 2007

Aliasing

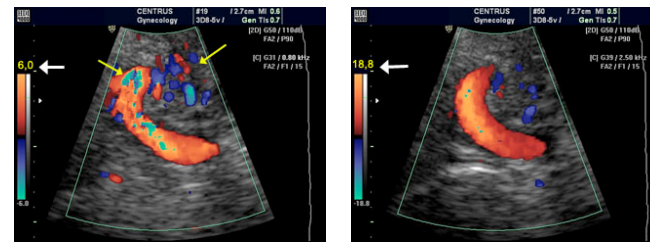

http://www.centrus.com.br/DiplomaFMF/SeriesFMF/doppler/capitulos-htmchapter_01.htm

TT Liu, BE280A, UCSD, Fall 2007

