

Bioengineering 280A
Principles of Biomedical Imaging

Fall Quarter 2008
MRI Lecture 3

Thomas Liu, BE280A, UCSD, Fall 2008

Sampling in k-space

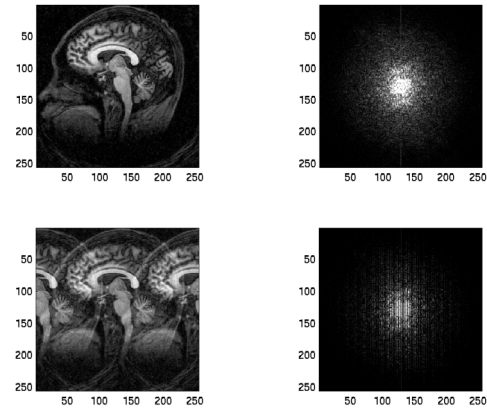

Aliasing

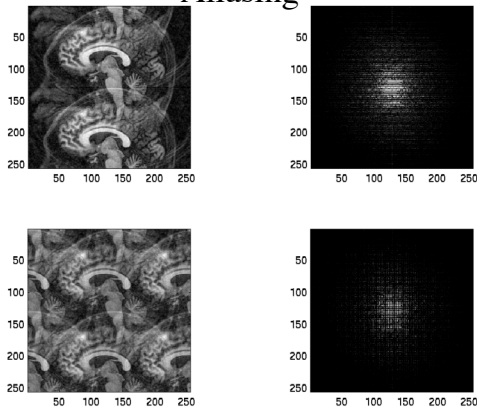

T1

Aliasing

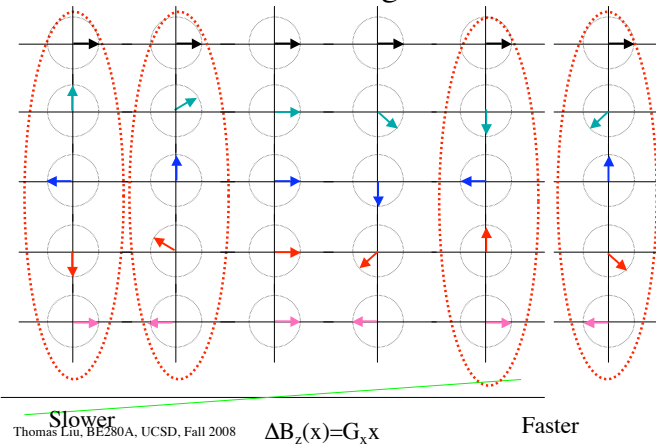

Intuitive view of Aliasing

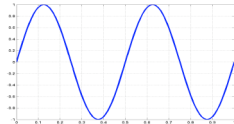

$$k_x = 2/FOV$$

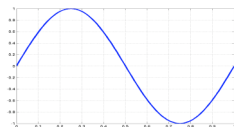

$$k_x = 1/FOV$$

Thomas Liu, BE280A, UCSD, Fall 2008

Fourier Sampling

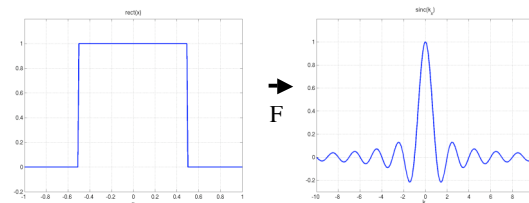

F

Instead of sampling the signal, we sample its Fourier Transform

Sample

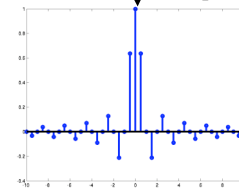

???

F⁻¹

Thomas Liu, BE280A, UCSD, Fall 2008

Fourier Sampling

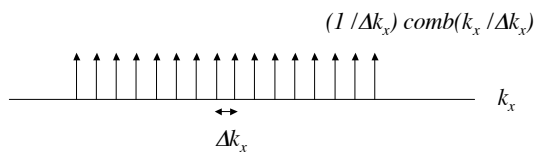

$$\begin{aligned} G_S(k_x) &= G(k_x) \frac{1}{\Delta k_x} \text{comb}\left(\frac{k_x}{\Delta k_x}\right) \\ &= G(k_x) \sum_{n=-\infty}^{\infty} \delta(k_x - n\Delta k_x) \\ &= \sum_{n=-\infty}^{\infty} G(n\Delta k_x) \delta(k_x - n\Delta k_x) \end{aligned}$$

Thomas Liu, BE280A, UCSD, Fall 2008

Fourier Sampling -- Inverse Transform

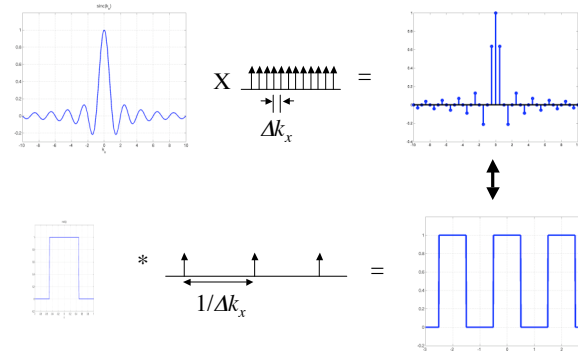

Thomas Liu, BE280A, UCSD, Fall 2008

Fourier Sampling -- Inverse Transform

$$\begin{aligned}
 g_s(x) &= F^{-1}[G_s(k_x)] \\
 &= F^{-1}\left[G(k_x) \frac{1}{\Delta k_x} \text{comb}\left(\frac{k_x}{\Delta k_x}\right)\right] \\
 &= F^{-1}[G(k_x)] * F^{-1}\left[\frac{1}{\Delta k_x} \text{comb}\left(\frac{k_x}{\Delta k_x}\right)\right] \\
 &= g(x) * \text{comb}(x\Delta k_x) \\
 &= g(x) * \sum_{n=-\infty}^{\infty} \delta(x\Delta k_x - n) \\
 &= g(x) * \frac{1}{\Delta k_x} \sum_{n=-\infty}^{\infty} \delta\left(x - \frac{n}{\Delta k_x}\right) \\
 &= \frac{1}{\Delta k_x} \sum_{n=-\infty}^{\infty} g\left(x - \frac{n}{\Delta k_x}\right)
 \end{aligned}$$

Thomas Liu, BE280A, UCSD, Fall 2008

Nyquist Condition

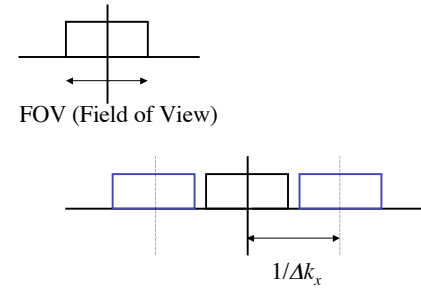

To avoid overlap, $1/\Delta k_x > \text{FOV}$, or equivalently, $\Delta k_x < 1/\text{FOV}$

Thomas Liu, BE280A, UCSD, Fall 2008

Aliasing

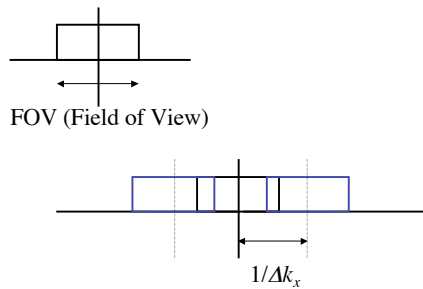

Aliasing occurs when $1/\Delta k_x < \text{FOV}$

Thomas Liu, BE280A, UCSD, Fall 2008

Aliasing Example

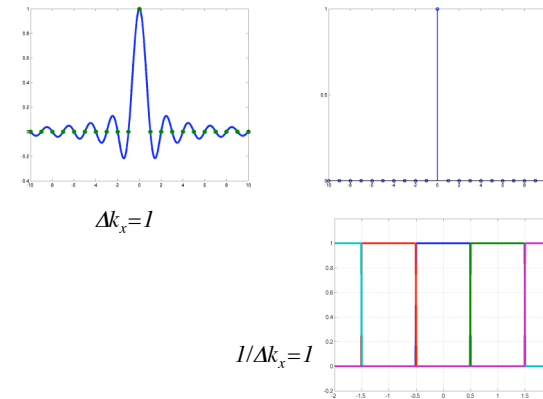

Thomas Liu, BE280A, UCSD, Fall 2008

2D Comb Function

$$\begin{aligned} \text{comb}(x,y) &= \sum_{m=-\infty}^{\infty} \sum_{n=-\infty}^{\infty} \delta(x-m,y-n) \\ &= \sum_{m=-\infty}^{\infty} \delta(x-m) \sum_{n=-\infty}^{\infty} \delta(y-n) \\ &= \text{comb}(x)\text{comb}(y) \end{aligned}$$

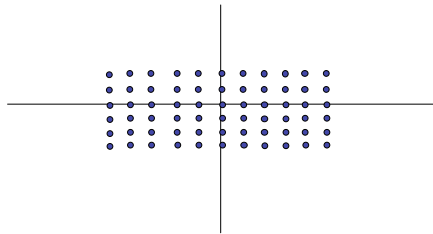

Thomas Liu, BE280A, UCSD, Fall 2008

Scaled 2D Comb Function

$$\begin{aligned} \text{comb}(x/\Delta x, y/\Delta y) &= \text{comb}(x/\Delta x)\text{comb}(y/\Delta y) \\ &= \Delta x \Delta y \sum_{m=-\infty}^{\infty} \sum_{n=-\infty}^{\infty} \delta(x-m\Delta x)\delta(y-n\Delta y) \end{aligned}$$

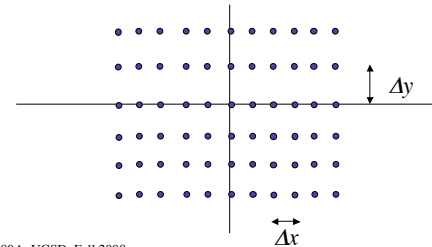

Thomas Liu, BE280A, UCSD, Fall 2008

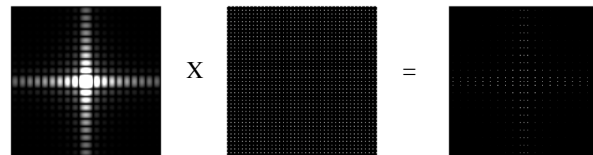

Thomas Liu, BE280A, UCSD, Fall 2008

2D k-space sampling

$$\begin{aligned} G_S(k_x, k_y) &= G(k_x, k_y) \frac{1}{\Delta k_x \Delta k_y} \text{comb}\left(\frac{k_x}{\Delta k_x}, \frac{k_y}{\Delta k_y}\right) \\ &= G(k_x, k_y) \sum_{m=-\infty}^{\infty} \sum_{n=-\infty}^{\infty} \delta(k_x - m\Delta k_x, k_y - n\Delta k_y) \\ &= \sum_{m=-\infty}^{\infty} \sum_{n=-\infty}^{\infty} G(m\Delta k_x, n\Delta k_y) \delta(k_x - m\Delta k_x, k_y - n\Delta k_y) \end{aligned}$$

Thomas Liu, BE280A, UCSD, Fall 2008

2D k-space sampling

$$\begin{aligned}
 g_S(x, y) &= F^{-1} \left[G_S(k_x, k_y) \right] \\
 &= F^{-1} \left[G(k_x, k_y) \frac{1}{\Delta k_x \Delta k_y} \text{comb} \left(\frac{k_x}{\Delta k_x}, \frac{k_y}{\Delta k_y} \right) \right] \\
 &= F^{-1} \left[G(k_x, k_y) \right] * F^{-1} \left[\frac{1}{\Delta k_x \Delta k_y} \text{comb} \left(\frac{k_x}{\Delta k_x}, \frac{k_y}{\Delta k_y} \right) \right] \\
 &= g(x, y) * * \text{comb}(x \Delta k_x) \text{comb}(y \Delta k_y) \\
 &= g(x) * * \sum_{m=-\infty}^{\infty} \sum_{n=-\infty}^{\infty} \delta(x \Delta k_x - m) \delta(y \Delta k_y - n) \\
 &= g(x) * * \frac{1}{\Delta k_x \Delta k_y} \sum_{m=-\infty}^{\infty} \sum_{n=-\infty}^{\infty} \delta \left(x - \frac{m}{\Delta k_x} \right) \delta \left(y - \frac{n}{\Delta k_y} \right) \\
 &= \frac{1}{\Delta k_x \Delta k_y} \sum_{m=-\infty}^{\infty} \sum_{n=-\infty}^{\infty} g \left(x - \frac{m}{\Delta k_x}, y - \frac{n}{\Delta k_y} \right)
 \end{aligned}$$

Thomas Liu, BE280A, UCSD, Fall 2008

Nyquist Conditions

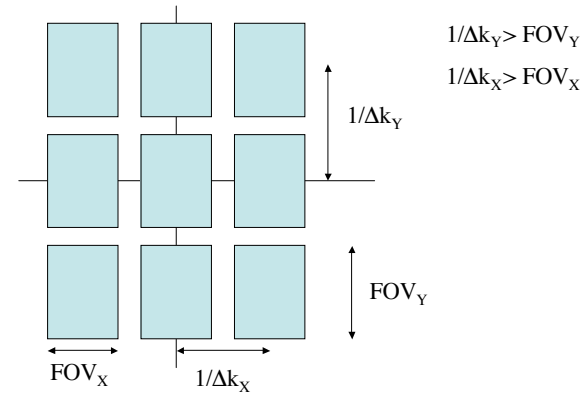

Thomas Liu, BE280A, UCSD, Fall 2008

Windowing

Windowing the data in Fourier space

$$G_W(k_x, k_y) = G(k_x, k_y) W(k_x, k_y)$$

Results in convolution of the object with the inverse transform of the window

$$g_W(x, y) = g(x, y) * w(x, y)$$

Thomas Liu, BE280A, UCSD, Fall 2008

Resolution

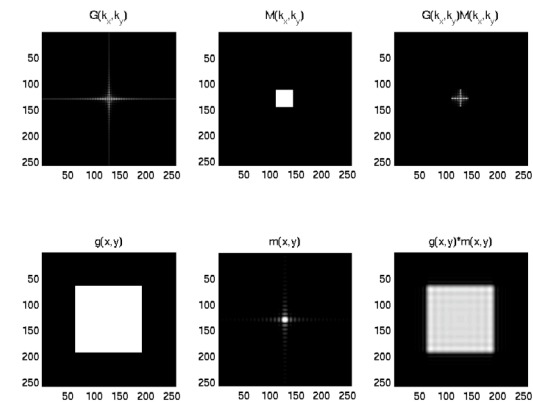

1

Windowing Example

$$W(k_x, k_y) = \text{rect}\left(\frac{k_x}{W_{k_x}}\right) \text{rect}\left(\frac{k_y}{W_{k_y}}\right)$$

$$w(x, y) = F^{-1} \left[\text{rect}\left(\frac{k_x}{W_{k_x}}\right) \text{rect}\left(\frac{k_y}{W_{k_y}}\right) \right]$$

$$= W_{k_x} W_{k_y} \text{sinc}(W_{k_x} x) \text{sinc}(W_{k_y} y)$$

$$g_w(x, y) = g(x, y) * W_{k_x} W_{k_y} \text{sinc}(W_{k_x} x) \text{sinc}(W_{k_y} y)$$

Thomas Liu, BE280A, UCSD, Fall 2008

Effective Width

$$w_E = \frac{1}{w(0)} \int_{-\infty}^{\infty} w(x) dx$$

Example

$$w_E = \frac{1}{1} \int_{-\infty}^{\infty} \text{sinc}(W_{k_x} x) dx$$

$$= F[\text{sinc}(W_{k_x} x)] \Big|_{k_x=0}$$

$$= \frac{1}{W_{k_x}} \text{rect}\left(\frac{k_x}{W_{k_x}}\right) \Big|_{k_x=0}$$

$$= \frac{1}{W_{k_x}}$$

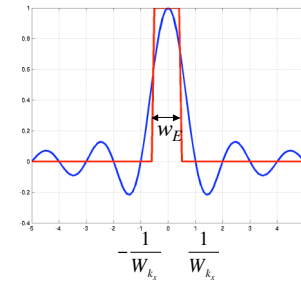

Thomas Liu, BE280A, UCSD, Fall 2008

Resolution and spatial frequency

With a window of width W_{k_x} , the highest spatial frequency is $W_{k_x}/2$.
This corresponds to a spatial period of $2/W_{k_x}$.

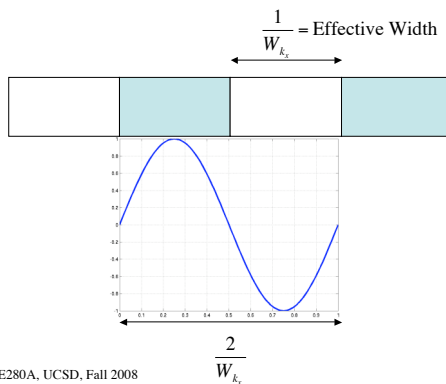

Thomas Liu, BE280A, UCSD, Fall 2008

Windowing Example

$$g(x, y) = [\delta(x) + \delta(x-1)]\delta(y)$$

$$g_w(x, y) = [\delta(x) + \delta(x-1)]\delta(y) * W_{k_x} W_{k_y} \text{sinc}(W_{k_x} x) \text{sinc}(W_{k_y} y)$$

$$= W_{k_x} W_{k_y} \left([\delta(x) + \delta(x-1)] * \text{sinc}(W_{k_x} x) \right) \text{sinc}(W_{k_y} y)$$

$$= W_{k_x} W_{k_y} \left(\text{sinc}(W_{k_x} x) + \text{sinc}(W_{k_x} (x-1)) \right) \text{sinc}(W_{k_y} y)$$

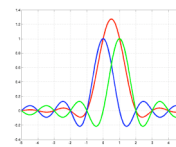

$W_{k_x} = 1$

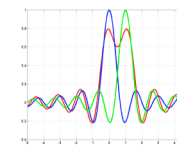

$W_{k_x} = 1.5$

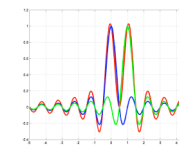

$W_{k_x} = 2$

Thomas Liu, BE280A, UCSD, Fall 2008

Sampling and Windowing

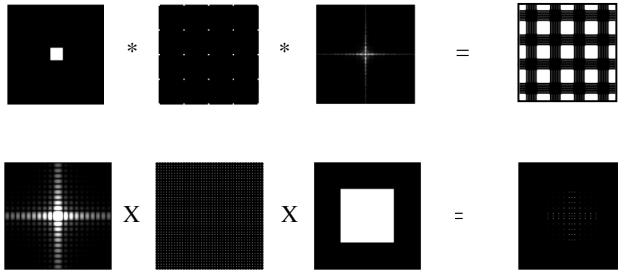

Thomas Liu, BE280A, UCSD, Fall 2008

Sampling and Windowing

Sampling and windowing the data in Fourier space

$$G_{SW}(k_x, k_y) = G(k_x, k_y) \frac{1}{\Delta k_x \Delta k_y} \text{comb}\left(\frac{k_x}{\Delta k_x}, \frac{k_y}{\Delta k_y}\right) \text{rect}\left(\frac{k_x}{W_{k_x}}, \frac{k_y}{W_{k_y}}\right)$$

Results in replication and convolution in object space.

$$g_{SW}(x, y) = W_{k_x} W_{k_y} g(x, y) ** \text{comb}(\Delta k_x x, \Delta k_y y) ** \text{sinc}(W_{k_x} x) \text{sinc}(W_{k_y} y)$$

Thomas Liu, BE280A, UCSD, Fall 2008

Sampling in k_y

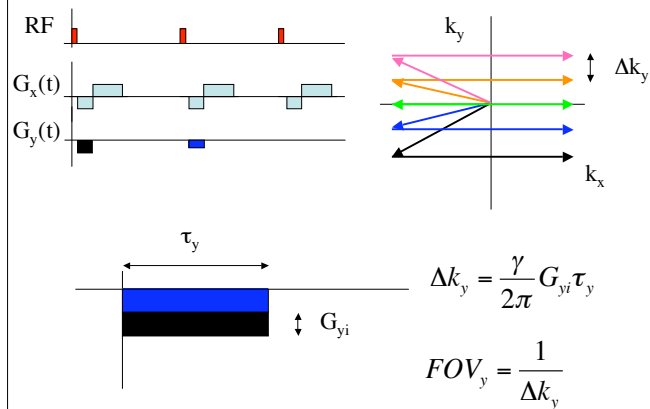

Thomas Liu, BE280A, UCSD, Fall 2008

Sampling in k_x

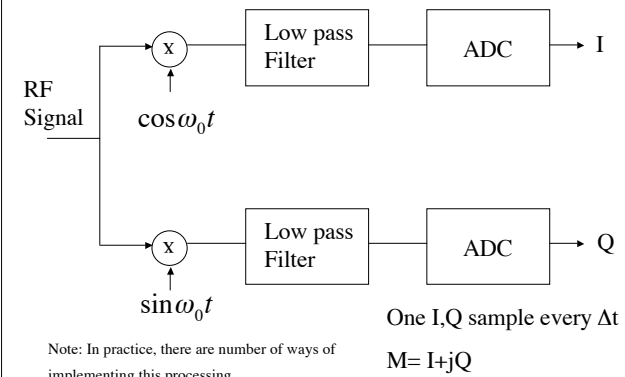

Note: In practice, there are number of ways of implementing this processing.
Thomas Liu, BE280A, UCSD, Fall 2008

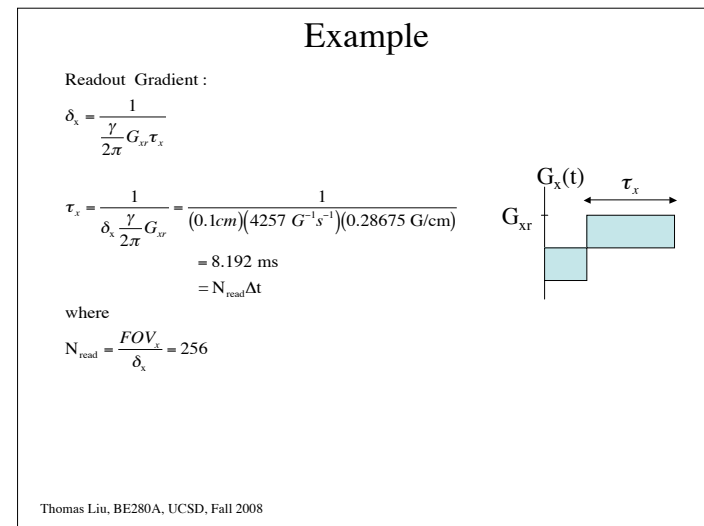
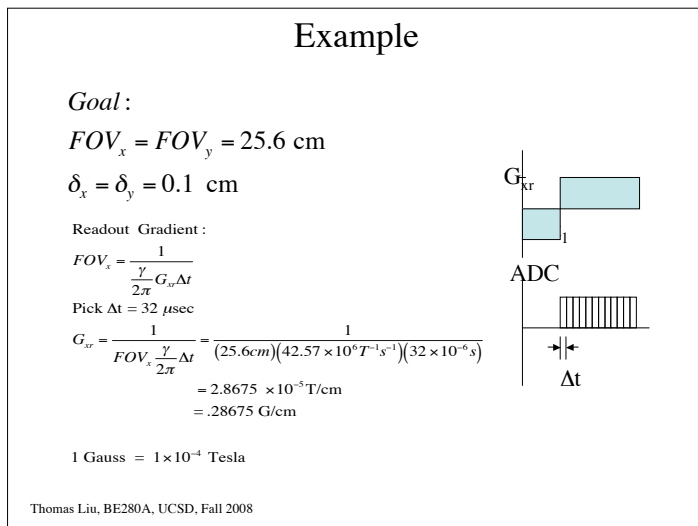
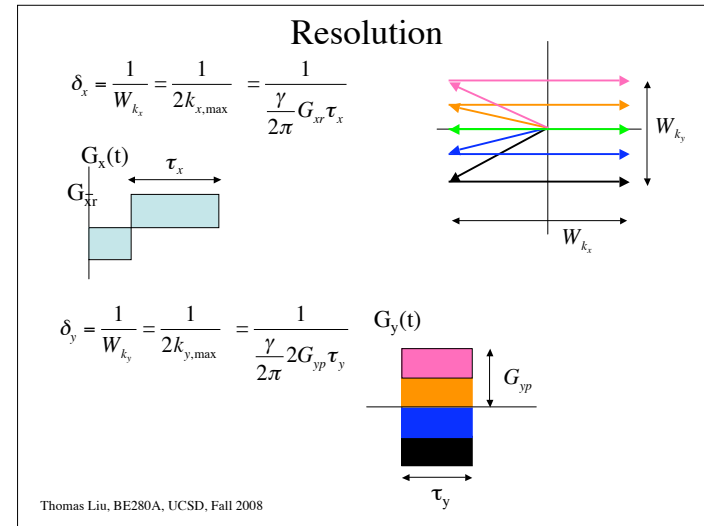
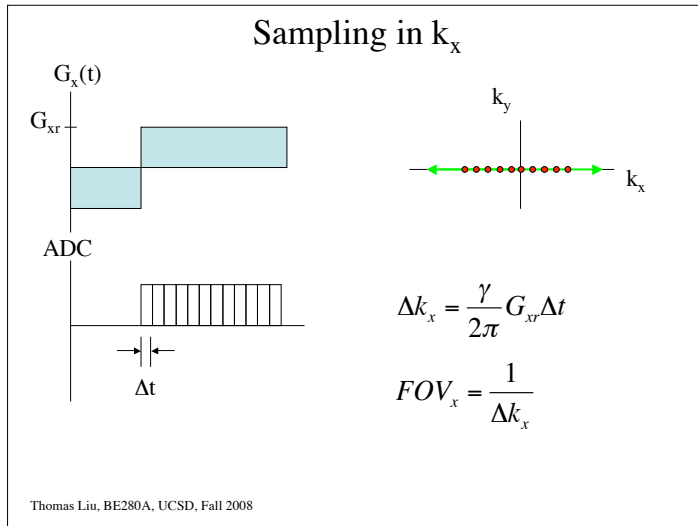

Example

Phase - Encode Gradient :

$$FOV_y = \frac{1}{\frac{\gamma}{2\pi} G_{pe} \tau_y}$$

Pick $\tau_y = 4.096 \text{ msec}$

$$G_{pe} = \frac{1}{FOV_y \frac{\gamma}{2\pi} \tau_y} = \frac{1}{(25.6 \text{ cm})(42.57 \times 10^6 \text{ T}^{-1} \text{ s}^{-1})(4.096 \times 10^{-3} \text{ s})}$$

$$= 2.2402 \times 10^{-7} \text{ T/cm}$$

$$= .00224 \text{ G/cm}$$

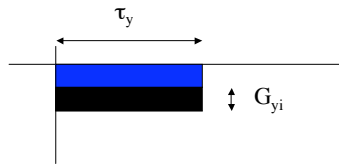

Thomas Liu, BE280A, UCSD, Fall 2008

Example

Phase - Encode Gradient :

$$\delta_y = \frac{1}{\frac{\gamma}{2\pi} 2 G_{sp} \tau_y}$$

$$G_{sp} = \frac{1}{\delta_y 2 \frac{\gamma}{2\pi} \tau_y} = \frac{1}{(0.1 \text{ cm})(4257 \text{ G}^{-1} \text{ s}^{-1})(4.096 \times 10^{-3} \text{ s})}$$

$$= 0.2868 \text{ G/cm}$$

$$= \frac{N_p}{2} G_{pe}$$

where

$$N_p = \frac{FOV_y}{\delta_y} = 256$$

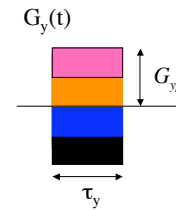

Thomas Liu, BE280A, UCSD, Fall 2008

Sampling

In practice, an even number (typically power of 2) sample is usually taken in each direction to take advantage of the Fast Fourier Transform (FFT) for reconstruction.

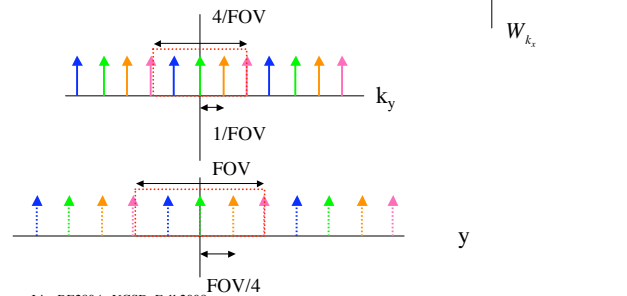

Thomas Liu, BE280A, UCSD, Fall 2008

Example

Consider the k-space trajectory shown below. ADC samples are acquired at the points shown with $\Delta t = 10 \mu\text{sec}$. The desired FOV (both x and y) is 10 cm and the desired resolution (both x and y) is 2.5 cm. Draw the gradient waveforms required to achieve the desired FOV and resolution. Label the waveform with the gradient amplitudes required to achieve the desired FOV and resolution. Also, make sure to label the time axis correctly.

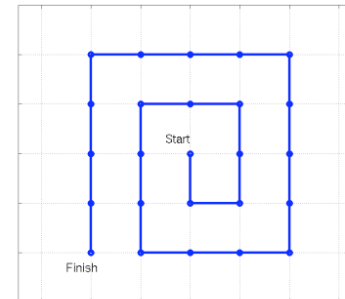

Thomas Liu, BE280A, UCSD, Fall 2008

SCAN TIMING

of Echoes: 1, 2, 3, 4

TE: Min Full

TR: 750

Inv. Time

T12

Flip Angle

Echo Train Length

Bandwidth: 25

Bandwidth2

ACQUISITION TIMING

Freq: 352, Freq DIR: A/P

Phase: 192, Auto Center Freq: Water

NEX: 2.0, Flow Comp Direction

Phase FOV: 0.75, Autoshim, Phase Correct

of Acqs Before Pause, Agent

SCANNING RANGE

FDV: 22, Start, L/R Center, P/A Center

Slice Thickness: 5.0, End

Spacing: 2.0, # Slices, Table Delta

ACTUAL End

Thomas Liu, BE280A, UCSD, Fall 2008 GE Medical Systems 2003

Gibbs Artifact



256x256 image

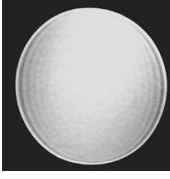

256x128 image

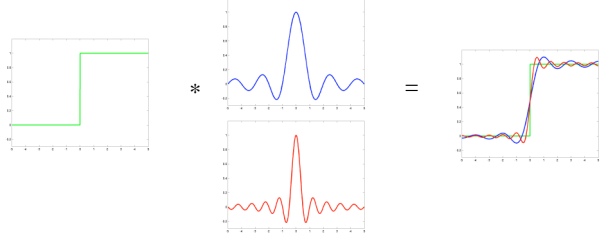

Thomas Liu, BE280A, UCSD, Fall 2008 Images from <http://www.mritutor.org/mritutor/gibbs.htm>

Apodization

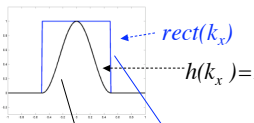

Hanning Window

$h(k_x) = 1/2(1 + \cos(2\pi k_x))$

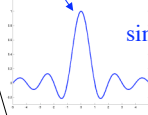

sinc(x)

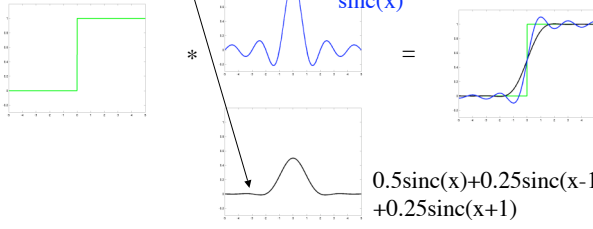

$0.5\text{sinc}(x) + 0.25\text{sinc}(x-1) + 0.25\text{sinc}(x+1)$

Thomas Liu, BE280A, UCSD, Fall 2008 Images from <http://www.mritutor.org/mritutor/gibbs.htm>

Aliasing and Bandwidth

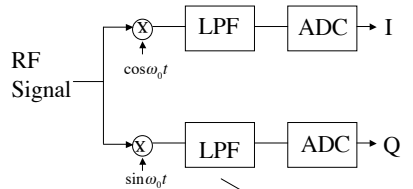

Temporal filtering in the readout direction limits the readout FOV. So there should never be aliasing in the readout direction.

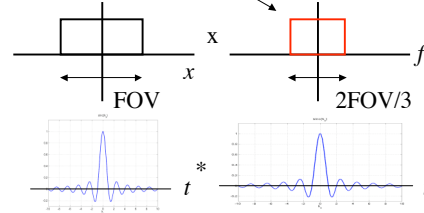

Thomas Liu, BE280A, UCSD, Fall 2008

